

AN112 Series Housings

**Aluminium & Polyamide
Pressure, 10 Bar
Ports, 1/8" or 1/4"
Element, 12.32.□**

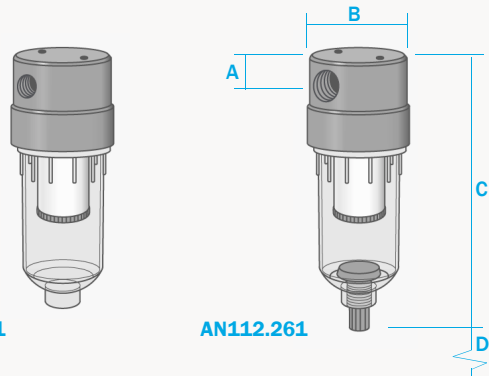

The AN112 series filter housings have an anodised aluminium head with polyamide bowl and internals. They are supplied with 1/8" or 1/4" ports and have a range of drain options. These housings are suitable for compressed air systems and general filtration applications.

Standard housings have NPT ports and include Viton gaskets. Other gaskets types are available as an option. BSPT and BSPP port types are also available.

Principal Specifications

Housing Model	AN112.101	AN112.111	AN112.161	AN112.201	AN112.211	AN112.261
Port Size - NPT	1/8"	1/8"	1/8"	1/4"	1/4"	1/4"
Drain - NPT	None	1/8"	Manual	None	1/8"	Manual
Maximum Pressure - Bar	10	10	10	10	10	10
Maximum Temperature - °C	50	50	50	50	50	50
Materials of Construction (1)						
Head	AL	AL	AL	AL	AL	AL
Bowl	PA	PA	PA	PA	PA	PA
Internals	PA	PA	PA	PA	PA	PA
Gaskets	Viton	Viton	Viton	Viton	Viton	Viton
Principal Dimensions						
A - mm	11	11	11	11	11	11
B - mm	40	40	40	40	40	40
C - mm	97	97	106	97	97	106
D - mm	40	40	40	40	40	40
Volume - cc	25	25	25	25	25	25
Weight - kg	0.1	0.1	0.1	0.1	0.1	0.1
Accessories						
Standard Gasket Set	GVAN112	GVAN112	GVAN112	GVAN112	GVAN112	GVAN112
Nitrile Gasket Set	GNAN112	GNAN112	GNAN112	GNAN112	GNAN112	GNAN112
EPDM Gasket Set	GEAN112	GEAN112	GEAN112	GEAN112	GEAN112	GEAN112
Mounting Bracket	MBAN11	MBAN11	MBAN11	MBAN11	MBAN11	MBAN11
Filter Element Code (2)	12.32.□	12.32.□	12.32.□	12.32.□	12.32.□	12.32.□

Notes (1) Material abbreviations - AL = Aluminium, PA = Polyamide, EPDM = Ethylene-Propylene

(2) Replace the □ with the grade required, e.g. 12.32.5CK, 12.32.S25V, 12.32.T20