

# SH017

## SP76 Modular Filter Housing

<b>Materials</b>	<b>316L Stainless Steel</b>
<b>Pressure</b>	<b>350 Bar</b>
<b>Ports</b>	<b>SP76 &amp; 1/8"</b>
<b>Element</b>	<b>10.32.□</b>

The SH027 series SP76 filter housings are designed for SP76 compliant modular sample systems. The housings can be used for particulate or coalescing applications. Coalescing housings have a drain port. If a housing is used for coalescing any liquid in the sample will flow to the 1/8" NPT drain port.

The coalescing housings should only be used on a substrate that is mounted in the horizontal plane with the drain port at the lowest point below the inlet and outlet ports.

The housing design allows a quick change of the element as all the line connections are arranged in the body of the housing.

The housings are free from welds and comply with NACE MR-01-75 and are CE marked in accordance with PED 97/23/EC.

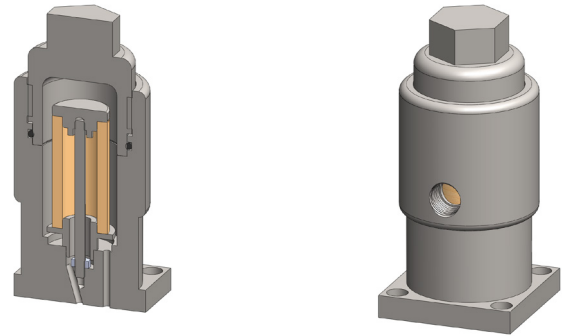

### Technical Specifications

Housing Model	SH017.L01	SH017.R01	SH017.L11	SH017.R11
Inlet/Outlet Connections	SP76	SP76	SP76	SP76
Drain	None	None	1/8" NPT	1/8" NPT
Maximum Pressure, Bar	350	350	350	350
Maximum Temperature, °C (1)	200	200	200	200
Flow Direction	Left to Right	Right to Left	Left to Right	Right to Left
Substrate Plane	Any	Any	Horizontal	Horizontal
Inlet	Hole 1	Hole 3	Hole 2	Hole 2
Outlet	Hole 2	Hole 2	Hole 3	Hole 1
<b>Materials of Construction (2)</b>				
Head, Bowl & Internals	316L SS	316L SS	316L SS	316L SS
Seals (3)	Viton	Viton	Viton	Viton
Filter Element Code (4)	10.32.□	10.32.□	10.32.□	10.32.□
<b>Principal Dimensions in mm</b>				
Diameter	38	38	38	38
Height	82	82	82	82
Volume, cc	15	15	15	15
Weight, kg	0.3	0.3	0.3	0.3

#### Notes

- (1) Above 200°C the pressure rating is reduced, consult us for the exact rating at any specific temperature
- (2) Material abbreviations, 316L SS = 316L Stainless Steel
- (3) Add suffix for other seal types, PTFE = .T, Chemraz = .C, Nitrile = N, Kalrez = .K, EPDM = .E, Silicone = .S, (e.g. SH027.R11.T)
- (4) Replace the □ with the grade required, e.g. 10.57.5CK



## Contact Us

**Classic Filters Ltd.**  
**Sextant Park**  
**Neptune Close**  
**Rochester**  
**Kent**  
**England**  
**ME2 4LU**

**T** +44 (0)1634 724224  
**F** +44 (0)1634 724234  
**E** [info@classicfilters.com](mailto:info@classicfilters.com)  
**W** [www.classicfilters.com](http://www.classicfilters.com)

## Follow Us



<http://www.linkedin.com/company/classic-filters-ltd.>



<http://www.twitter.com/classicfilters>