

Materials 316L Stainless Steel
Pressure 150 Bar
Ports 1/8" or 1/4"
Element 12.57.□
Membrane MT.33.□

SM125 combination housings have a coalescing filter element and a PTFE membrane in a single unit.

The porous PTFE membrane is supported by a sintered porous stainless steel disc on the outlet side. The wet sample gas enters the inlet port and then through the coalescing element to remove the bulk of the liquid and solid particles and then to the membrane. Any liquid in the gas sample will flow to the drain port. This port can be used as a bypass function for the main flow.

Standard housings have NPT ports and include Viton seals. Other seal types are available as an option. BSPT and BSPP port types are also available.

The housings are free from welds and comply with NACE MR-01-75.

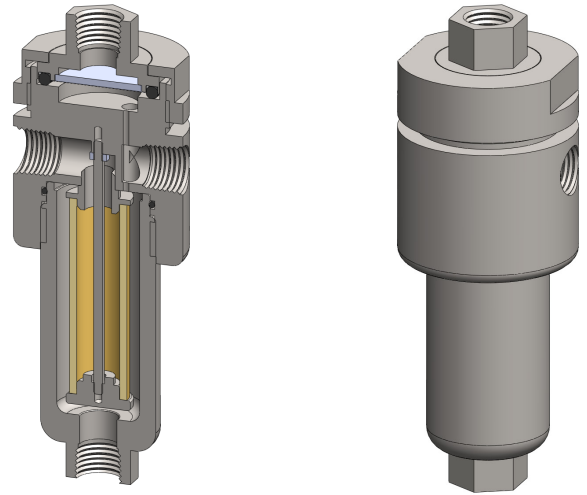

Technical Specifications

Housing Model	SM125.111	SM125.221
Port Size	1/8" NPT	1/4" NPT
Drain & Bypass Ports	1/8" NPT	1/4" NPT
Maximum Pressure, Bar	150	150
Maximum Temperature, °C (1)	150	150
Materials of Construction (2)		
Head, Bowl & Internals	316L SS	316L SS
Seals (3)	Viton	Viton
Filter Element Code (4)	12.57.□	12.57.□
Membrane Code (5)	MT.33.□	MT.33.□
Principal Dimensions in mm		
Diameter	50	50
Height	135	135
Volume, cc	45	45
Weight, kg	1.0	1.0
Accessories		
Mounting Bracket	MBSM115	MBSM115

Notes

- (1) Maximum temperature of 150°C is due to the PTFE membrane
- (2) Material abbreviations, 316L SS = 316L Stainless Steel
- (3) Add suffix for other seal types, PTFE = .T, Chemraz = .C, Nitrile = N, Kalrez = .K, EPDM = .E, Silicone = .S, (e.g. SM125.221.T)
- (4) Replace the □ with the element grade required, e.g. 12.57.5CK
- (5) Replace the □ with the membrane grade required, e.g. MT.33.M2



Contact Us

Classic Filters Ltd.
Sextant Park
Neptune Close
Rochester
Kent
England
ME2 4LU

T +44 (0)1634 724224
F +44 (0)1634 724234
E info@classicfilters.com
W www.classicfilters.com

Follow Us



<http://www.linkedin.com/company/classic-filters-ltd.>



<http://www.twitter.com/classicfilters>